



Mammal Study Merit Badge

Troop 344 and 9344
Pemberville, OH



Mammal Study Requirements

1. Explain the meaning of "animal," "invertebrate," "vertebrate," and "mammal." Name three characteristic that distinguish mammals from all other animals.
2. Explain how the animal kingdom is classified. Explain where mammals fit in the classification of animals. Classify three mammals from phylum through species.





Mammal Study Requirements

3. Do ONE of the following:
 - a. Spend 3 hours in each of two different kinds of natural habitats or at different elevations. List the different mammal species and individual members that you identified by sight or sign. Tell why all mammals do not live in the same kind of habitat.
 - b. Spend 3 hours on each of 5 days on at least a 25- acre area (about the size of 3 1/2 football fields). List the mammal species you identified by sight or sign.
 - c. From study and reading, write a simple life history of one nongame mammal that lives in your area. Tell how this mammal lived before its habitat was affected in any way by humans. Tell how it reproduces, what it eats, and its natural habitat. Describe its dependency upon plants, upon other animals (including humans), and how they depend upon it. Tell how it is helpful or harmful to humankind.





Mammal Study Requirements

4. Do ONE of the following:
 - a. Under the guidance of a nature center or natural history museum, make two study skins of rats or mice. Tell the uses of study skins and mounted specimens respectively.
 - b. Take good pictures of two kinds of mammals in the wild. Record the date(s), time of day, weather conditions, approximate distance from the animal, habitat conditions, and any other factors you feel may have influenced the animal's activity and behavior.
 - c. Write a life history of a native game mammal that lives in your area, covering the points outlined in requirement 3c. List sources for this information.
 - d. Make and bait a tracking pit. Report what mammals and other animals came to the bait.
 - e. Visit a natural history museum. Report on how specimens are prepared and cataloged. Explain the purposes of museums.
 - f. Write a report of 500 words on a book about a mammal species.
 - g. Trace two possible food chains of carnivorous mammals from soil through four stages to the mammal.





Mammal Study Requirements

5. Working with your counselor, select and carry out one project that will influence the numbers of one or more mammals.



Requirement 1



Explain the meaning of "animal," "invertebrate," "vertebrate," and "mammal." Name three characteristic that distinguish mammals from all other animals.



What are Animals?

- Animals are multicellular, eukaryotic organisms in the biological kingdom Animalia.
- With few exceptions, animals consume organic material, breathe oxygen, are able to move, and can reproduce sexually.
- Over 1.5 million living animal species have been described—of which around 1 million are insects—but it has been estimated there are over 7 million animal species in total.

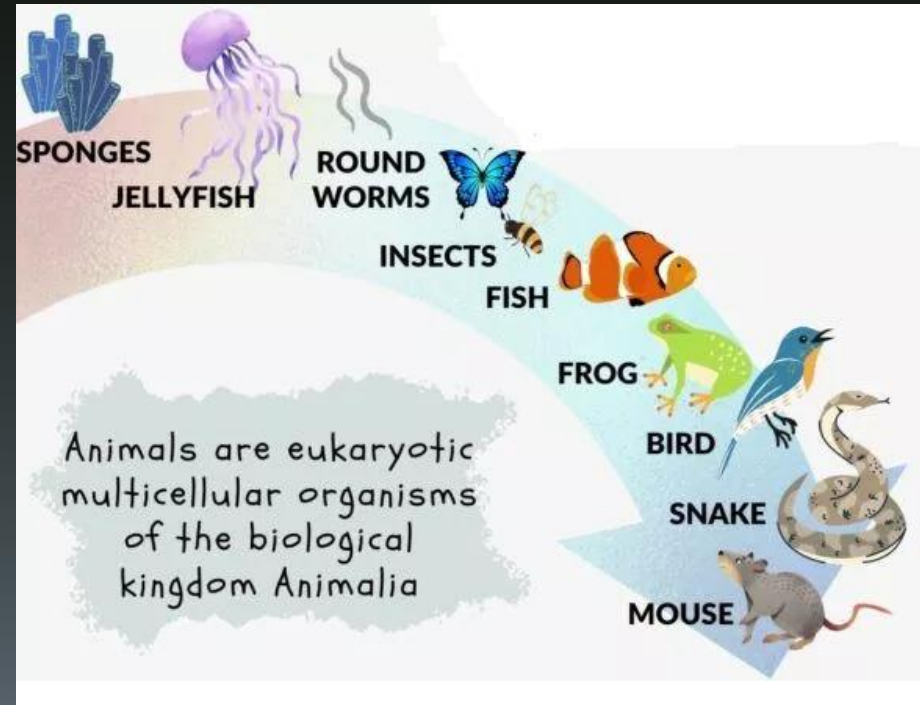

What are Invertebrates?

- Invertebrates are any animals that lack a vertebral column or backbone.

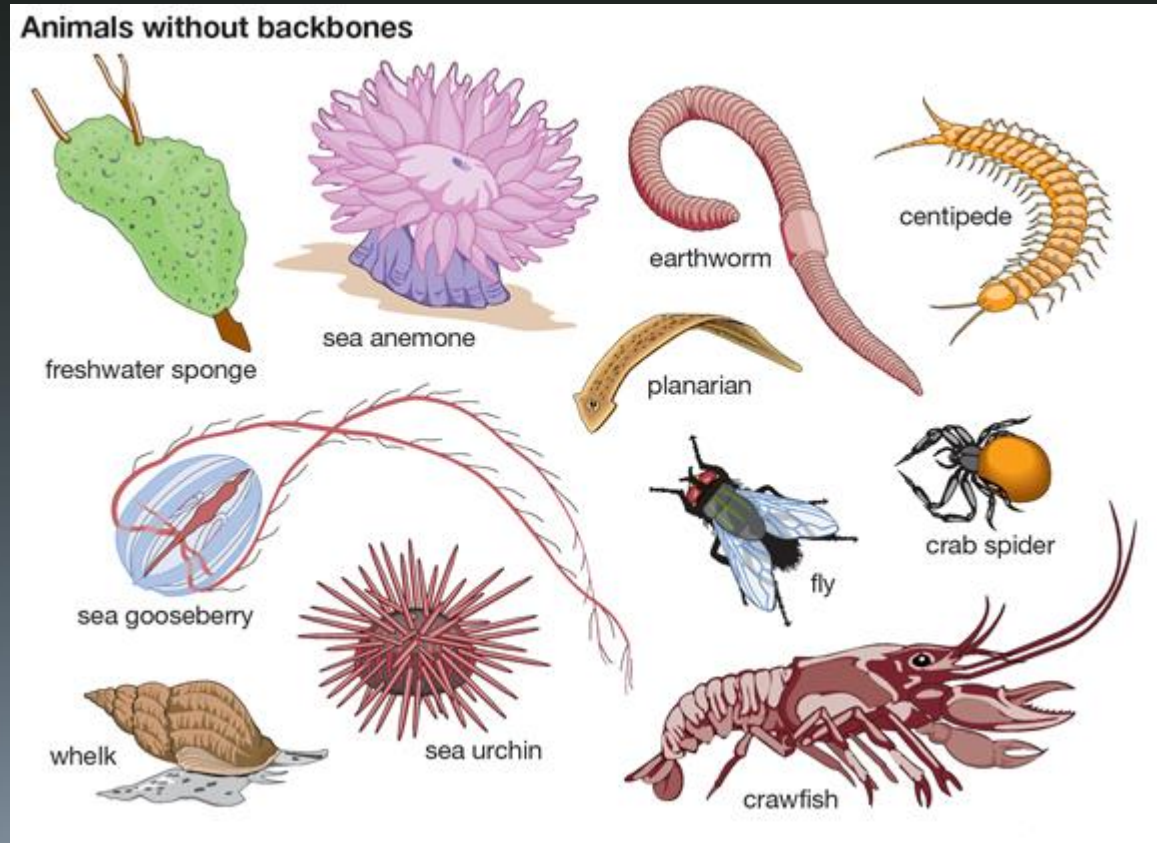

What are Vertebrates?

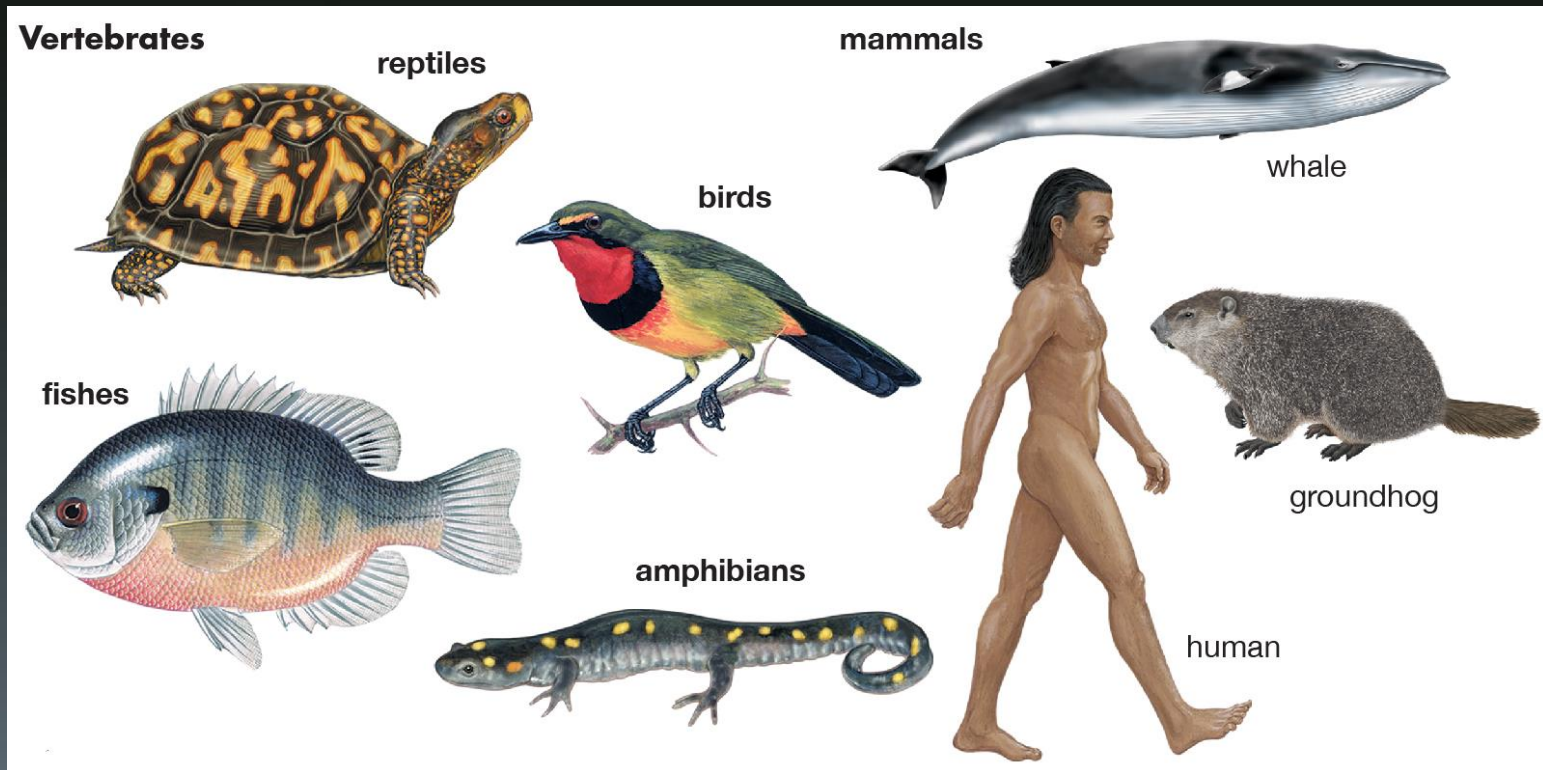

- Vertebrates are animals that have a backbone or spinal column, also called vertebrae.
- These animals include fish, birds, mammals, amphibians, and reptiles.



What are Mammals?

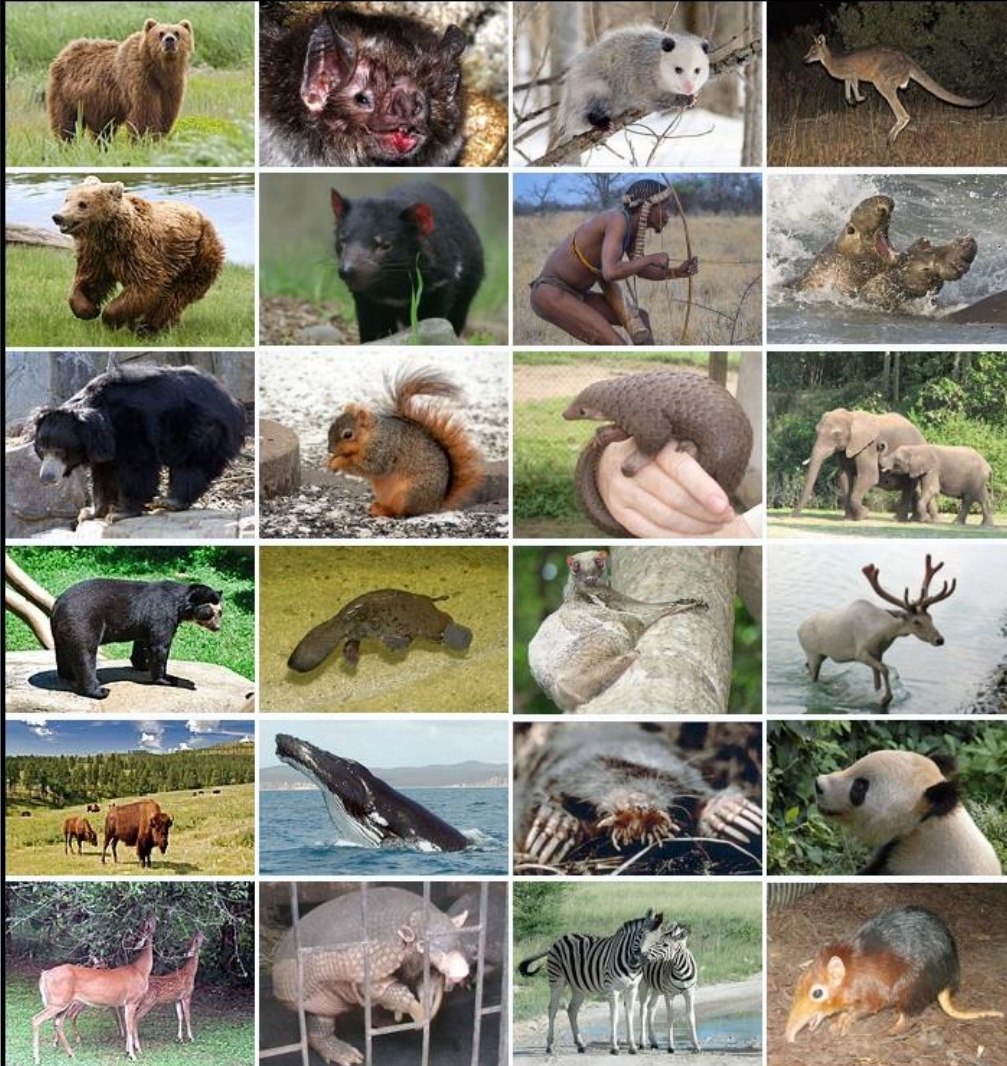

- A mammal is a warm-blooded vertebrate animal of the class Mammalia that is distinguished by:
 - The possession of hair or fur,
 - The secretion of milk by females for the nourishment of the young, (typically) the birth of live young,
 - A neocortex (a region of the brain),
 - And three middle ear bones.



Requirement 2



Explain how the animal kingdom is classified. Explain where mammals fit in the classification of animals. Classify three mammals from phylum through species.







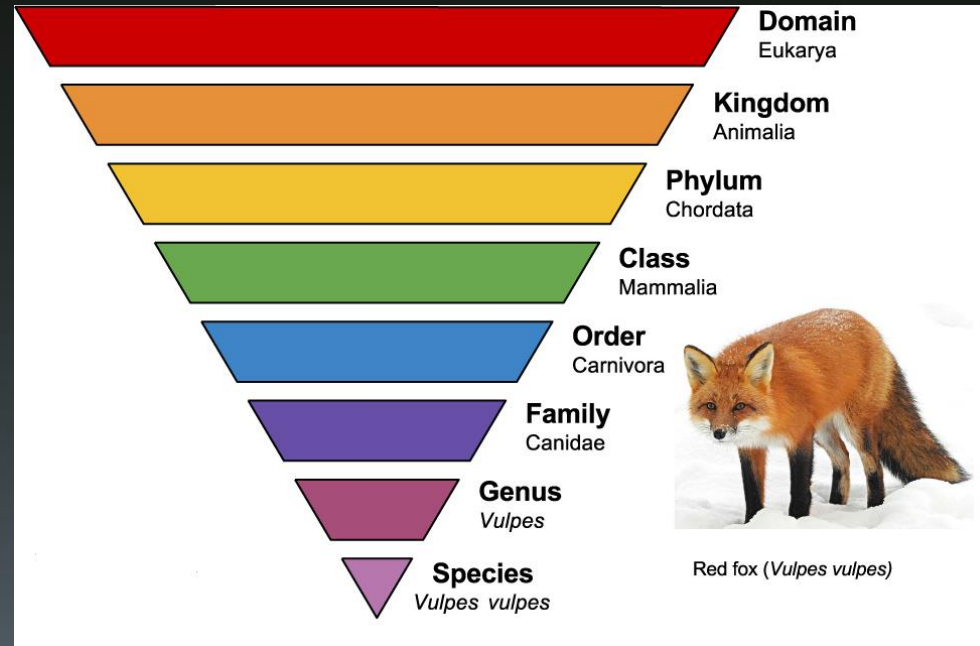



Classification of Organisms

- In order to study living things better, scientists classify (arrange) them into a series of groups according to the features they share.
- At the top of the classification system is the Domain, the largest grouping.
- Next is the Kingdoms.
 - There are 5 Kingdoms: Plants, Animals, Fungi, Bacteria, and Protists.
- The kingdoms are divided into ever smaller categories.
- The smaller the category, the fewer the organisms there are in it and the more features they have in common.
- The species is the smallest grouping of all containing just one kind of organism.



Classification of Mammals

Classification of the Brown Bear

Taxonomic Group	Number of Species	Examples
Domain Eukarya	About 4–10 million	
Kingdom Animalia	About 2 million	
Phylum Chordata	About 50,000	
Class Mammalia	About 5,000	
Order Carnivora	About 270	
Family Ursidae	8	
Genus <i>Ursus</i>	4	
Species <i>Ursus arctos</i>	1	

Classification of Dogs

KINGDOM

Animalia

PHYLUM

Chordata

CLASS

Mammalia

ORDER

Carnivora

FAMILY

Canidae

GENUS

Canis

SPECIES

familiaris



Classification of Polar Bears

Kingdom Animalia



Phylum Chordata



Class Mammalia



Order Carnivora



Family Ursidae



Genus Ursus



Species



Ursus maritimus



Classification of Humans

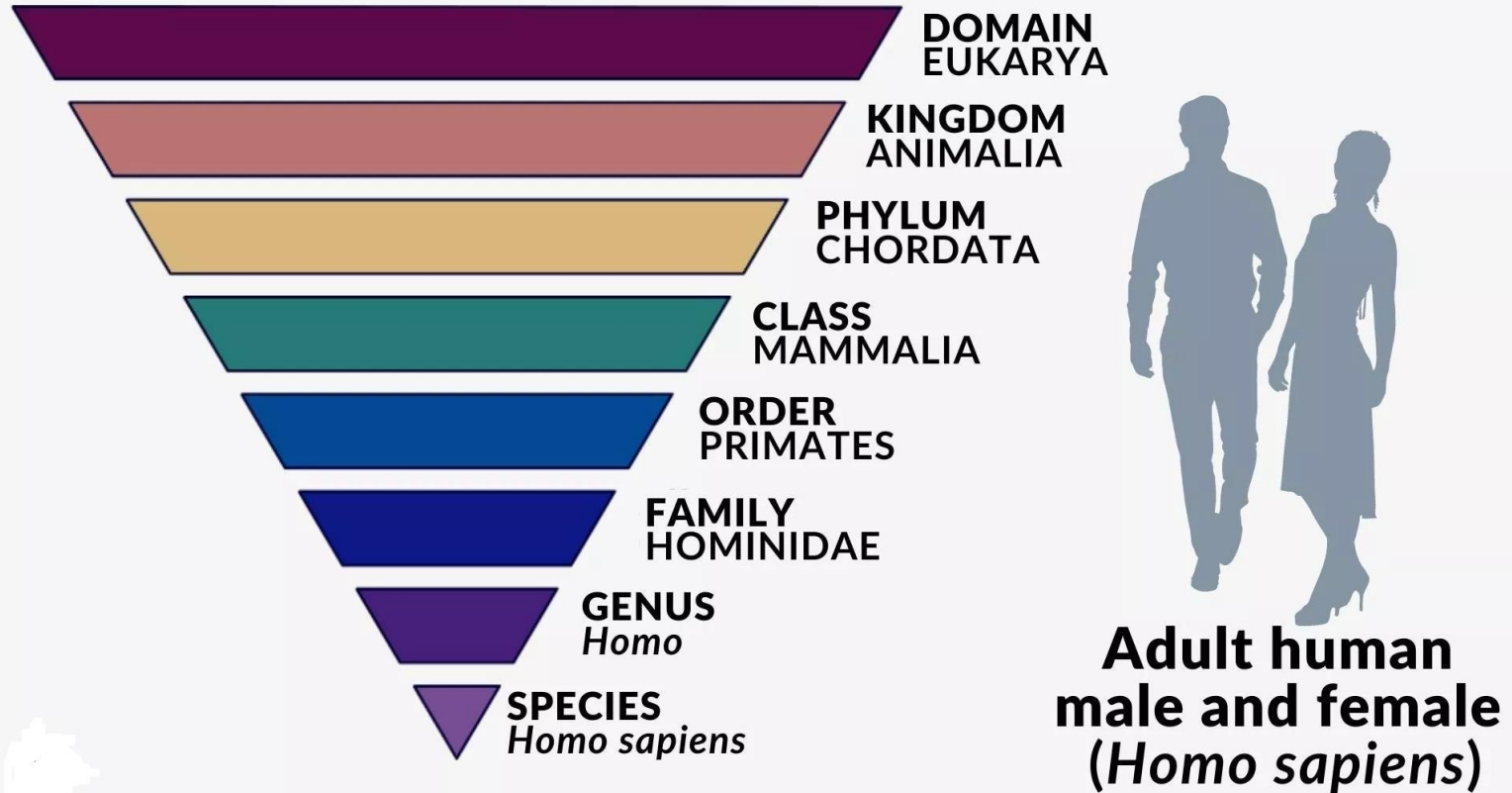

Requirement 3



3. Do ONE of the following:
 - a. Spend 3 hours in each of two different kinds of natural habitats or at different elevations. List the different mammal species and individual members that you identified by sight or sign. Tell why all mammals do not live in the same kind of habitat.
 - b. Spend 3 hours on each of 5 days on at least a 25- acre area (about the size of 3 1/2 football fields). List the mammal species you identified by sight or sign.
 - c. From study and reading, write a simple life history of one nongame mammal that lives in your area. Tell how this mammal lived before its habitat was affected in any way by humans. Tell how it reproduces, what it eats, and its natural habitat. Describe its dependency upon plants, upon other animals (including humans), and how they depend upon it. Tell how it is helpful or harmful to humankind.



Requirement 3c



- Click on the following link to visit the [Ohio Department of Natural Resources](#) website to learn about the life history of one nongame mammal native to the State of Ohio.
- Download the [Mammals of Ohio Field Guide](#) for additional information.



Requirement 4



Do ONE of the following:

- a. Under the guidance of a nature center or natural history museum, make two study skins of rats or mice. Tell the uses of study skins and mounted specimens respectively.
- b. Take good pictures of two kinds of mammals in the wild. Record the date(s), time of day, weather conditions, approximate distance from the animal, habitat conditions, and any other factors you feel may have influenced the animal's activity and behavior.
- c. Write a life history of a native game mammal that lives in your area, covering the points outlined in requirement 3c. List sources for this information.
- d. Make and bait a tracking pit. Report what mammals and other animals came to the bait.
- e. Visit a natural history museum. Report on how specimens are prepared and cataloged. Explain the purposes of museums.
- f. Write a report of 500 words on a book about a mammal species.
- g. Trace two possible food chains of carnivorous mammals from soil through four stages to the mammal.



Requirement 4c



- Download the [Ohio Hunting and Trapping Regulations Guide](#) to identify a game mammal native to Ohio.
- Click on the following link to visit the [Ohio Department of Natural Resources](#) website to learn about the life history of game mammals native to the State of Ohio.



Requirement 5



Working with your counselor, select and carry out one project that will influence the numbers of one or more mammals.



OWMA
OHIO WILDLIFE
MANAGEMENT ASSOCIATION



Managing Mammals

- All mammals need food, water, shelter, and living space.
- Without all four they cannot survive.
- And so, if you want to influence their numbers, you must adjust the environment to their needs.
- Examples:
 - If you would like to see more cottontail rabbits around your home, you might plant shrubs for food and build a brush pile for cover.
 - If your building is overrun with mice and rats, you would want to eliminate them by cleaning up trash piles and keep a tight lid on garbage cans.
 - The following pages contain additional examples of possible projects.



Making a Bat House

- You will need the following materials:
 - One 2-by-4-foot sheet of 1/2-inch outdoor grade plywood
 - An 8-inch piece of 1-by-2-inch pine
 - 20 to 30 1 1/4-inch coated deck or exterior-grade Phillips screws
 - One pint of water-based black exterior stain
 - One pint of water-based exterior primer
 - One quart of flat, water-based exterior paint or stain
 - One tube of paintable latex caulk
 - A 1-by-3-by-28-inch board (optional, but recommended)
 - Black asphalt shingles or galvanized metal (optional)
 - 10 7/8-inch roofing nails (optional)



Making a Bat House

To construct the bat house, follow these steps.

- **Step 1**—Measure and cut the plywood sheet into three pieces, measuring 26 1/2 inches by 2 feet, 16 1/2 inches by 2 feet, and 5 inches by 2 feet.
- **Step 2**—Roughen one side of the largest piece by cutting horizontal grooves with a sharp object or a saw. Space the grooves 1/2 inch apart, cutting 1/32 inch to 1/16 inch deep.

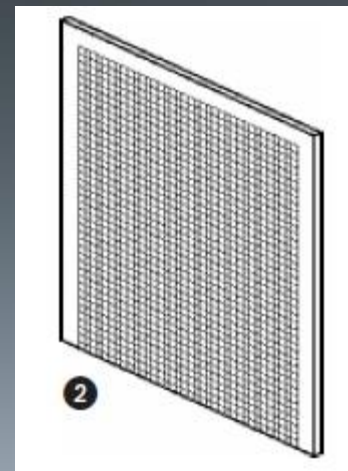
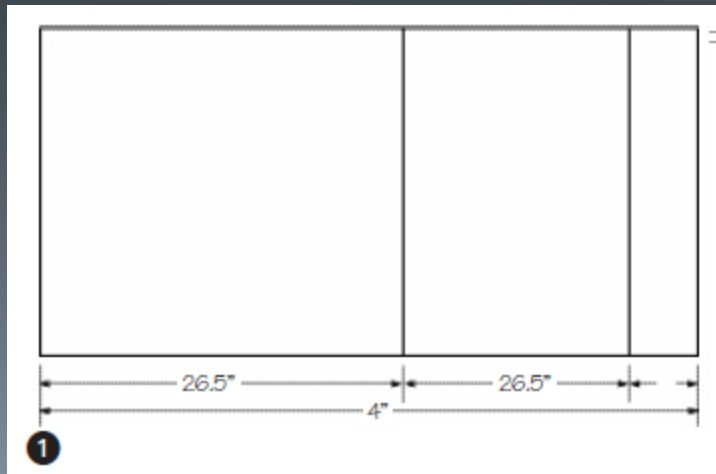

Making a Bat House

- **Step 3**—Apply two coats of black, water-based stain on one side of the grooved board and one side of the other two cut boards. **Note:** Do not use paint, because it will fill the grooves in the backboard, making it unusable.
- **Step 4**—Measure and cut the pine strip into one 24-inch piece and two 20 1/4-inch pieces. Apply a strip of caulk to the pine pieces, then attach them to the backboard. Reinforce with the screws.

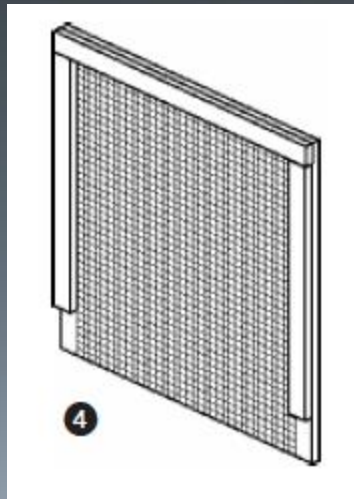

Making a Bat House

- **Step 5**—Apply caulk to the pine pieces again, then attach the front board. Reinforce the front of the house with screws.
- **Step 6**—Caulk around all outside joints to further seal the roosting chamber.
- **Step 7 (optional)**—Attach the 1-by-3-by-28-inch board to the top of the house as a roof.
- **Step 8**—Apply primer to the assembled bat house and follow with two coats of exterior paint or stain.
- **Step 9 (optional)**—Use roofing nails to attach shingles or galvanized metal to the roof.

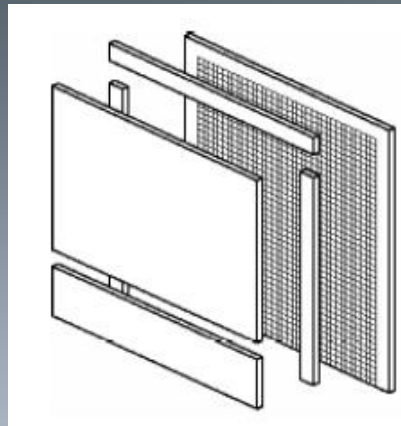
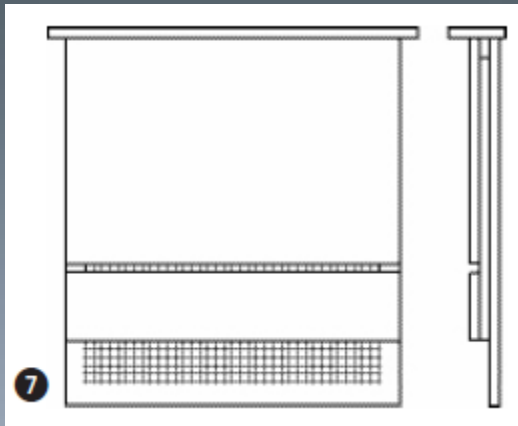

Making a Squirrel Nest Box

- Click on the following link for [Gray and Fox Squirrels Nest Box Plans](#)



Making a Raccoon Nest Box

- Click on the following link for [Raccoon Nest Box Plans](#)

